

Pipe Fittings



www.panamengineers.com

Introduction

PANAM has been in the field of manufacturing precision Pipe Fittings and Instrumentation valves since the last Two decades. With a team of dedicated specialists **PANAM** has always endeavored to satisfy their customers ever widening demands with unmatched precision.



With the latest in-house machinery and infrastructure under one roof, **PANAM** is manufacturing a wide range of Pipe Fittings and Instrumentation products in different sizes and metals like brass, stainless steel, monel and in various other metals as per the customer's specific requirements. Variety of end connections - Male & Female NPT, BSPP, BSPT, ISO tapered pipe ends, Tube / Pipe socket weld.

PANAM Pipe Fittings are 100% factory tested and are NACE certified with Heat code traceability. Maximum working pressure upto 20,000 psig (1378 bar) or Higher available upon request

- API ISO 9001:2008 Certified
- API ISO TS 29001 Certified
- API Spec Q1 Certified
- API 6A Certified
- API 6D Certified
- API 600 Certified
- API 602 Certified
- MFG. Facility Approved by ABS Ind.
- ASTM F1387-99
- Leak Test Approved by TUV
- CE Marking



Contents

<p>Features & Ordering Information 01</p>	<p>Hex Nipples NPT 02</p> 	<p>Hex Nipples ISO Tapered 02</p> 
<p>Hex Nipples ISO Parallel 02</p> 	<p>Hex Nipples NPT x ISO Tapered 03</p> 	<p>Hex Nipples NPT x ISO Parallel 03</p> 
<p>Hex Nipples NPT x SAE/MS Straight 03</p> 	<p>Hex Nipples NPT x Metric 04</p> 	<p>Bulkhead Union ISO Parallel 04</p> 
<p>Swivel Connector ISO Parallel 04</p> 	<p>Swivel Union ISO Parallel 05</p> 	<p>Hex Reducing Nipples NPT 05</p> 
<p>Hex Reducing Nipples ISO Parallel 06</p> 	<p>Hex Reducing Nipples ISO Parallel x NPT 06</p> 	<p>Hex Long Nipples NPT 07</p> 
<p>Hex Long Nipples ISO Tapered 08</p> 	<p>Close Nipples NPT 08</p> 	<p>Close Nipples ISO Tapered 09</p> 
<p>Long Pipe Nipples NPT 09</p> 	<p>Hex Couplings NPT 10</p> 	<p>Hex Couplings ISO Tapered 10</p> 
<p>Hex Couplings ISO Parallel 10</p> 	<p>Reducing Hex Couplings NPT 10</p> 	<p>Adapters NPT 11</p> 
<p>Adapters NPT x ISO Tapered 11</p> 	<p>Adapters ISO Parallel 11</p> 	<p>Adapters NPT x ISO Parallel 11</p> 
<p>Adapters ISO Tapered 12</p> 	<p>Adapters ISO Tapered x NPT 12</p> 	<p>Adapters NPT x SAE/MS Straight 12</p> 
<p>Adapters ISO Parallel x NPT 12</p> 	<p>Reducing Adapters NPT 13</p> 	<p>Reducing Adapters ISO Tapered 13</p> 
<p>Reducing Adapters ISO Parallel 14</p> 	<p>Reducing Bushing NPT 14</p> 	<p>Reducing Bushing NPT x ISO Tapered 15</p> 

Contents

Reducing Busing

SAE / MS Straight

15



Hex Plugs

NPT

16



Plugs

ISO Tapered

16



Plugs

ISO Parallel

16



Plugs

SAE / MS Straight

17



Plugs

Metric

17



Hallow Hex Plugs

NPT

17



Hallow Hex Plugs

ISO Tapered

17



Hallow Hex Plugs

SAE / MS Straight

18



Pipe Caps

NPT

18



Union

NPT

18



Union

ISO Tapered

18



Female Elbow

NPT

19



Female Elbow

ISO Tapered

19



Female Elbow

ISO Parallel

19



Male Elbow

NPT

20



Male Elbow

ISO Tapered

20



Male Elbow

ISO Parallel

20

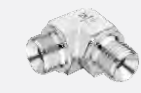

Swivel Male Elbow

ISO Parallel

21



Swivel Union Elbow

ISO Parallel

21



Street Elbow

NPT

22



Female Tee

NPT

23



Female Tee

ISO Parallel

23



Male Tee

NPT

23



Male Tee

ISO Parallel

24



Female Branch Tee

NPT

24



Female Run Tee

NPT

24



Male Street Tee

NPT

25



Male Branch Tee

NPT

25



Swivel Branch Tee

ISO Parallel

25



Swivel Run Tee

ISO Parallel

26



Swivel Union Tee

ISO Parallel

26



Female Cross

NPT

26



Female Cross

ISO Tapered

26



Features

- Size Ranges from 1/16" to 2"
- To avoid Galling threads are hardened with smooth surface which helps to extend the fitting service life.
- For smooth flow path elbows are designed with radius junction.
- All Fittings are marked with Size, Material and Heat code for easy source tracing.
- All threads are capped for protection and properly packaged
- Straight fittings are manufactured from bar stock & Forged fittings are manufactured from forgings
- All pipe threads meet the requirement if ASME/ANSI B1.20.1 for tapered pipe threads (NPT)
- Working pressure meets the requirements of ANSI/ASME B31.3 at ambient temperature.

Ordering Information

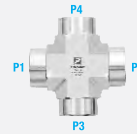
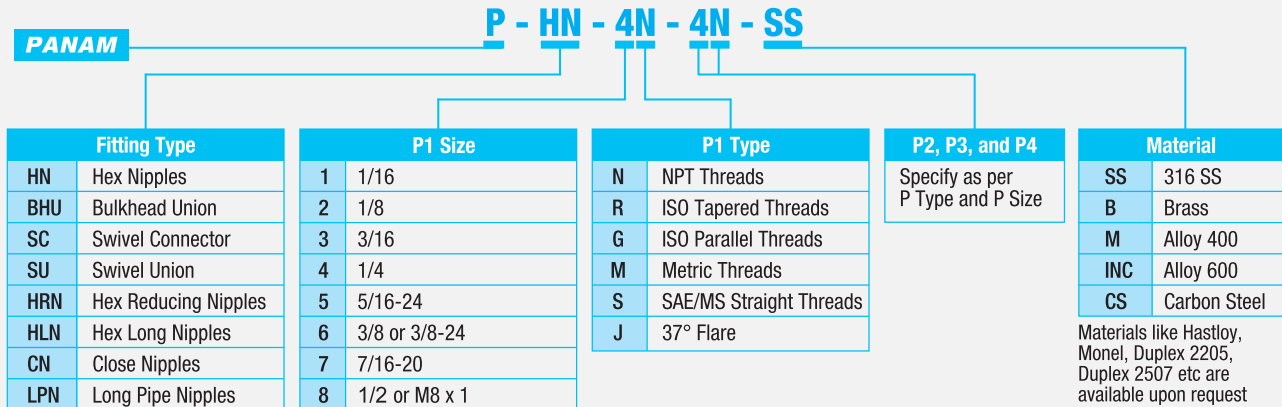

P1, P2, P3 & P4 Shall be described in the following orders. For tees the run shall proceed the branch, for cross the run shall proceed the branch

Pressure Ratings

Size	316 SS		Brass		Carbon Steel	
	Male	Female	Male	Female	Male	Female
1/16	11000	6700	5500	3300	11000	6700
1/8	10000	6500	5000	3200	10000	6500
1/4	8000	6600	4000	3300	8000	6600
3/8	7800	5300	3900	2600	7800	5300
1/2	7700	4900	3800	2400	7700	4900
3/4	7300	4600	3600	2300	7300	4600
1	5300	4400	2600	2200	5300	4400
1 1/4	6000	5000	3000	2500	6000	5000
1 1/2	5000	4600	2500	2300	5000	4600
2	3900	3900	1900	1900	3900	3900

- Pressure ratings are based on ASME Code for pressure piping B13.3, Process piping with allowable stress 20,000psi for 316 SS 10,000psi/Brass, and 20,000psi/Carbon Steel.
- To determine pressure ratings in accordance with B31.1 Power piping - 316 SS x 0.94 / CS x 0.75 / Brass material remains same.
- To determine kPa. multiply by 6.89

Installation Instructions

To ensure leak proof tight seal, **PANAM** recommends use of pipe thread sealant on all NPT threads. The most effective sealing method is the use of Teflon tape, Tape should be used on male NPT tapered threads. Clean both male and female tapered threads, wrap tape in direction of male tapered, cut off excess tape.

Material

Material	Bar Stock	Forging
316 SS	ASTM A276, ASME SA479, EN 1.4401	ASTM A182, ASME SA182, EN 1.4401
Alloy 400	ASTM B164, ASME SB164	ASTM B564, ASME SB564
Alloy 600	ASTM B166, ASME SB166	ASTM B564, ASME SB564
Brass	ASME B16/ASTM B453	ASTM B283
Carbon Steel	ASTM A108	ASTM A105

Thread Relevant Standards

NPT Threads	ASME B1.20.1, SAE AS71051
ISO Tapered Threads	ISO 7-1, BS 21, JIS B0203
ISO Parallel Threads	ISO 228, JIS B0202
SAE/MS	ASME B1.1, SAE J475
Metric	ISO 261

Instrumentation Pipe Fittings

Hex Nipple - NPT

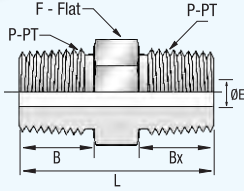

Part No	Pipe Size	Dimensions				
	P-PT, NPT	L	F	B	Bx	E
PHN-1N-SS	1/16	25.6	7.9	9.7	9.7	3.0
PHN-2N-SS	1/8	25.6	11.1	9.7	9.7	4.8
PHN-4N-SS	1/4	35.6	14.3	14.2	14.2	7.1
PHN-6N-SS	3/8	36.3	17.5	14.2	14.2	9.7
PHN-8N-SS	1/2	46.7	22.2	19.1	19.1	11.9
PHN-12N-SS	3/4	46.7	27.0	19.1	19.1	15.7
PHN-16N-SS	1	58.9	34.9	23.9	23.9	22.4
PHN-20N-SS	1 1/4	62.9	44.5	23.9	23.9	28.6
PHN-24N-SS	1 1/2	66.3	50.8	26.2	26.2	34.0
PHN-32N-SS	2	77.7	69.9	26.2	26.2	45.0

Hex Nipple - ISO Tapered

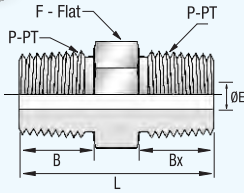

Part No	Pipe Size	Dimensions				
	P-PT, BSPT	L	F	B	Bx	E
PHN-2R-SS	1/8	25.6	11.1	9.7	9.7	4.8
PHN-4R-SS	1/4	35.6	14.3	14.2	14.2	7.1
PHN-6R-SS	3/8	36.3	17.5	14.2	14.2	9.7
PHN-8R-SS	1/2	46.7	22.2	19.1	19.1	11.9
PHN-12R-SS	3/4	46.7	27.0	19.1	19.1	15.7
PHN-16R-SS	1	58.9	34.9	23.9	23.9	22.4

Hex Nipple - ISO Parallel

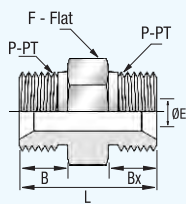

Part No	Pipe Size	Dimensions				
	P-PT, BSPP	L	F	B	Bx	E
PHN-2G-SS	1/8	23.5	14.0	8.0	8.0	3.5
PHN-4G-SS	1/4	31.5	19.0	11.0	11.0	4.7
PHN-6G-SS	3/8	34.7	22.0	12.0	12.0	7.9
PHN-8G-SS	1/2	40.7	27.0	14.0	14.0	11.1
PHN-10G-SS	5/8	45.2	30.0	16.0	16.0	14.3
PHN-12G-SS	3/4	45.2	32.0	16.0	16.0	16.7
PHN-16G-SS	1	51.9	41.0	19.0	19.0	22.2
PHN-20G-SS	1 1/4	61.4	50.0	20.0	20.0	28.6
PHN-24G-SS	1 1/2	67.4	55.0	22.0	22.0	33.3
PHN-32G-SS	2	76.4	70.0	25.0	25.0	46.0

Instrumentation Pipe Fittings

Hex Nipple - NPT x ISO Tapered

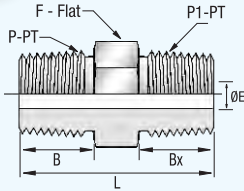

Part No	Pipe Size		Dimensions				
	P-PT, NPT	P1-PT, BSPT	L	F	B	Bx	E
PHN-2N-2R-SS	1/8	1/8	25.6	11.1	9.7	9.7	4.8
PHN-4N-4R-SS	1/4	1/4	35.6	14.3	14.2	14.2	7.1
PHN-6N-6R-SS	3/8	3/8	36.3	17.5	14.2	14.2	9.7
PHN-8N-8R-SS	1/2	1/2	46.7	22.2	19.1	19.1	11.9
PHN-12N-12R-SS	3/4	3/4	46.7	27.0	19.1	19.1	15.7
PHN-16N-16R-SS	1	1	58.9	34.9	23.9	23.9	22.4

Hex Nipple - NPT x ISO Parallel

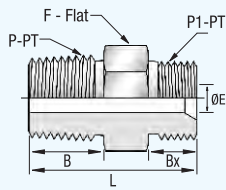

Part No	Pipe Size		Dimensions				
	P-PT, NPT	P1-PT, BSPP	L	F	B	Bx	E
PHN-2N-2G-SS	1/8	1/8	24.4	14.0	9.7	8.0	3.5
PHN-4N-4G-SS	1/4	1/4	33.4	19.0	14.2	11.0	4.7
PHN-6N-6G-SS	3/8	3/8	35.1	22.0	14.2	12.0	7.9
PHN-8N-8G-SS	1/2	1/2	43.4	22.0	19.1	14.0	11.0
PHN-12N-12G-SS	3/4	3/4	45.9	30.0	19.1	16.0	16.7
PHN-16N-16G-SS	1	1	54.5	41.0	23.9	19.0	22.2
PHN-20N-20G-SS	1 1/4	1 1/4	63.7	50.0	23.9	20.0	28.6
PHN-24N-24G-SS	1 1/2	1 1/2	68.5	55.0	26.2	22.0	33.3
PHN-32N-32G-SS	2	2	76.4	70.0	26.2	25.0	46.0

Hex Nipple - NPT x SAE / MS Straight

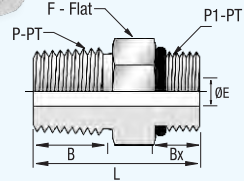

Part No	Pipe Size		Dimensions				
	P-PT, NPT	P1-PT, SAE	L	F	B	Bx	E
PHN-4N-7S-SS	1/4	7/16-20	30.5	14.3	14.2	9.1	5.1
PHN-6N-9S-SS	3/8	9/16-18	32.0	17.5	14.2	9.1	7.1
PHN-8N-12S-SS	1/2	3/4-16	38.9	22.2	19.1	11.2	10.7
PHN-12N-17S-SS	3/4	1 1/16-12	44.4	31.8	19.1	15.0	15.7
PHN-16N-21S-SS	1	1 5/16-12	50.8	38.1	23.9	15.0	22.4

Instrumentation Pipe Fittings

Hex Nipple - NPT x Metric

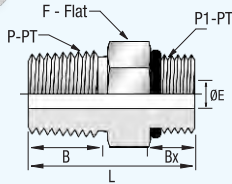

Part No	Pipe Size		Dimensions				
	P-PT, NPT	P1-PT, Metric	L	F	B	Bx	E
PHN-4N-8M-SS	1/4	M8 x1	29.0	14.3	14.2	9.0	3.2
PHN-4N-14M-SS	1/4	M14 x1.5	34.2	15.9	14.2	13.0	7.0
PHN-4N-16M-SS	1/4	M16 x 1.5	35.2	17.5	14.2	14.0	7.1
PHN-4N-20M-SS	1/4	M20 x 1.5	37.2	22.2	14.2	16.0	7.1
PHN-6N-14M-SS	3/8	M14 x1.5	34.2	17.5	14.2	13.0	7.0
PHN-6N-20M-SS	3/8	M20 x 1.5	37.2	22.2	14.2	16.0	9.5
PHN-6N-24M-SS	3/8	M24 x 1.5	38.2	25.4	14.2	17.0	9.5
PHN-8N-14M-SS	1/2	M14 x 1.5	39.1	22.2	19.1	13.0	7.2
PHN-8N-20M-SS	1/2	M20 x 1.5	42.0	22.2	19.1	16.0	10.0
PHN-8N-24M-SS	1/2	M24 x 1.5	43.5	25.4	19.1	17.0	11.9
PHN-12N-20M-SS	3/4	M20 x 1.5	42.1	27.0	19.1	16.0	10.8
PHN-12N-27M-SS	3/4	M27 x 2	46.7	38.8	19.1	18.0	15.8
PHN-16N-30M-SS	1	M30 x 2	56.3	34.9	23.9	20.0	19.4

Bulkhead Union - ISO Parallel

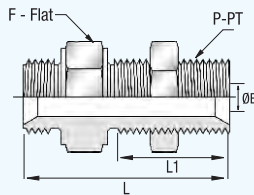

Part No	Pipe Size		Dimensions			
	P-PT, BSPP		L	L1	F	E
PBHU-4G-SS	1/4		46.8	28.0	19.0	4.7
PBHU-6G-SS	3/8		52.5	32.0	22.0	7.9
PBHU-8G-SS	1/2		59.0	35.0	27.0	11.1
PBHU-10G-SS	5/8		61.5	35.0	30.0	14.3
PBHU-12G-SS	3/4		64.5	38.0	32.0	16.7
PBHU-16G-SS	1		71.2	41.0	41.0	22.2
PBHU-20G-SS	1 1/4		82.7	44.0	50.0	28.6
PBHU-24G-SS	1 1/2		90.7	48.0	55.0	33.3

Swivel Connector - ISO Parallel

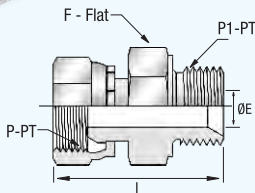

Part No	Pipe Size		Dimensions		
	P-PT, BSPP	P1PT, BSPP	L	F	E
PSC-4G-SWL-SS	1/4	1/4	36.6	19.0	4.7
PSC-4G-6G-SWL-SS	1/4	3/8	38.5	22.0	4.7
PSC-4G-8G-SWL-SS	1/4	1/2	42.0	27.0	4.7
PSC-6G-4G-SWL-SS	3/8	1/4	38.3	22.0	4.7
PSC-6G-SWL-SS	3/8	3/8	40.0	22.0	7.9
PSC-6G-8G-SWL-SS	3/8	1/2	43.6	27.0	7.9
PSC-8G-6G-SWL-SS	1/2	3/8	43.5	27.0	7.9
PSC-8G-SWL-SS	1/2	1/2	46.1	27.0	11.1
PSC-8G-12G-SWL-SS	1/2	3/4	48.0	32.0	11.1
PSC-12G-8G-SWL-SS	3/4	1/2	48.6	32.0	11.1
PSC-12G-SWL-SS	3/4	3/4	50.0	32.0	16.7
PSC-12G-16G-SWL-SS	3/4	1	54.3	41.0	16.7
PSC-16G-SWL-SS	1	1	57.3	41.0	22.2

Instrumentation Pipe Fittings

Swivel Union - ISO Parallel

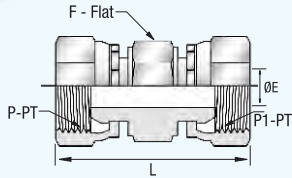

Part No	Pipe Size		Dimensions		
	P-PT, BSPP	P-PT1, BSPP	L	F	E
PSU-4G-SWL-SS	1/4	1/4	37.0	19.0	4.7
PSU-6G-4G-SWL-SS	3/8	1/4	38.6	22.0	4.7
PSU-6G-SWL-SS	3/8	3/8	40.5	22.0	7.9
PSU-8G-4G-SWL-SS	1/2	1/4	41.5	27.0	4.7
PSU-8G-6G-SWL-SS	1/2	3/8	42.9	27.0	7.9
PSU-8G-SWL-SS	1/2	1/2	45.8	27.0	11.1
PSU-10G-SWL-SS	5/8	5/8	47.5	30.0	14.3
PSU-12G-8G-SWL-SS	3/4	1/2	48.2	32.0	11.1
PSU-12G-SWL-SS	3/4	3/4	49.5	32.0	16.7
PSU-16G-SWL-SS	1	1	57.5	41.0	22.2
PSU-20G-SWL-SS	1 1/4	1 1/4	66.0	50.0	28.6
PSU-24G-SWL-SS	1 1/2	1 1/2	70.0	60.0	33.3

Hex Reducing Nipple - NPT

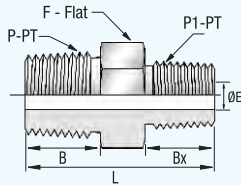

Part No	Pipe Size		Dimensions				
	P-PT, NPT	P1-PT, NPT	L	F	B	Bx	E
PHRN-2N-1N-SS	1/8	1/16	25.6	11.1	9.7	9.7	3.0
PHRN-4N-1N-SS	1/4	1/16	31.0	14.3	14.2	9.7	3.0
PHRN-4N-2N-SS	1/4	1/8	31.0	14.3	14.2	9.7	4.8
PHRN-6N-1N-SS	3/8	1/16	31.8	17.5	14.2	9.7	3.0
PHRN-6N-2N-SS	3/8	1/8	31.8	17.5	14.2	9.7	4.8
PHRN-6N-4N-SS	3/8	1/4	36.3	17.5	14.2	14.2	7.1
PHRN-8N-2N-SS	1/2	1/8	37.3	22.2	19.1	9.7	4.8
PHRN-8N-4N-SS	1/2	1/4	41.9	22.2	19.1	14.2	7.1
PHRN-8N-6N-SS	1/2	3/8	41.9	22.2	19.1	14.2	9.7
PHRN-12N-2N-SS	3/4	1/8	40.4	27.0	19.1	9.7	4.8
PHRN-12N-4N-SS	3/4	1/4	41.9	21.0	19.1	14.2	7.1
PHRN-12N-6N-SS	3/4	3/8	45.2	27.0	19.1	14.2	9.7
PHRN-12N-8N-SS	3/4	1/2	46.7	27.0	19.1	19.1	11.9
PHRN-16N-2N-SS	1	1/8	45.2	34.9	23.9	9.7	4.8
PHRN-16N-4N-SS	1	1/4	49.3	34.9	23.9	14.2	7.1
PHRN-16N-6N-SS	1	3/8	50.0	34.9	23.9	14.2	9.7
PHRN-16N-8N-SS	1	1/2	54.1	34.9	23.9	19.1	11.9
PHRN-16N-12N-SS	1	3/4	54.1	34.9	23.9	19.1	15.7
PHRN-20N-16N-SS	1 1/4	1	62.2	44.5	23.9	23.9	22.4

Instrumentation Pipe Fittings

Hex Reducing Nipple - ISO Parallel

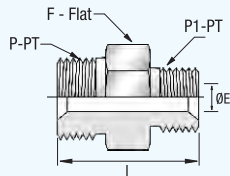

Part No	Pipe Size		Dimensions		
	P-PT, BSPP	P1-PT, BSPP	L	F	E
PHRN-4G-2G-SS	1/4	1/8	28.0	19.0	3.5
PHRN-6G-4G-SS	3/8	1/4	33.2	22.0	4.7
PHRN-8G-4G-SS	1/2	1/4	36.7	27.0	4.7
PHRN-8G-6G-SS	1/2	3/8	38.2	27.0	7.9
PHRN-10G-8G-SS	5/8	1/2	43.2	30.0	11.1
PHRN-12G-4G-SS	3/4	1/4	39.2	32.0	4.7
PHRN-12G-6G-SS	3/4	3/8	40.7	32.0	7.9
PHRN-12G-8G-SS	3/4	1/2	43.2	32.0	11.1
PHRN-12G-10G-SS	3/4	5/8	45.2	32.0	14.3
PHRN-16G-8G-SS	1	1/2	46.9	41.0	11.1
PHRN-16G-10G-SS	1	5/8	48.9	41.0	14.3
PHRN-16G-12G-SS	1	3/4	48.9	41.0	16.7
PHRN-20G-12G-SS	1 1/4	3/4	57.4	50.0	16.7
PHRN-20G-16G-SS	1 1/4	1	60.4	50.0	22.2
PHRN-24G-16G-SS	1 1/2	1	64.4	55.0	22.2
PHRN-24G-20G-SS	1 1/2	1 1/4	65.4	55.0	28.6
PHRN-32G-24G-SS	2	1 1/2	72.9	70.0	33.3

Hex Reducing Nipple - ISO Parallel x NPT

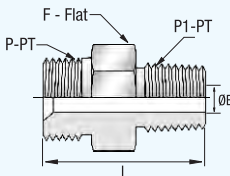

Part No	Pipe Size		Dimensions		
	P-PT, BSPP	P1-PT, NPT	L	F	E
PHRN-2G-4N-SS	1/8	1/4	28.9	14.0	3.5
PHRN-4G-2N-SS	1/4	1/8	28.9	19.0	3.5
PHRN-4G-6N-SS	1/4	3/8	33.4	19.0	4.7
PHRN-6G-4N-SS	3/8	1/4	35.1	22.0	4.7
PHRN-6G-8N-SS	3/8	1/2	39.9	22.0	7.9
PHRN-8G-6N-SS	1/2	3/8	38.6	27.0	7.9
PHRN-10G-8N-SS	5/8	1/2	45.9	27.0	11.1
PHRN-10G-12N-SS	5/8	3/4	45.9	30.0	14.3
PHRN-12G-8N-SS	3/4	1/2	46.0	32.0	11.1
PHRN-12G-16N-SS	3/4	1	50.8	36.0	16.7
PHRN-16G-12N-SS	1	3/4	49.6	41.0	16.7

Hex Long Nipples - NPT

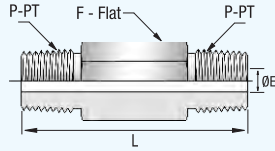

Part No	Pipe Size	Dimensions		
	P-PT, NPT	L	F	E
PHLN-2N-SS-L1.5	1/8	38.1	11.1	4.8
PHLN-2N-SS-L2.0	1/8	50.8	11.1	4.8
PHLN-2N-SS-L2.5	1/8	63.5	11.1	4.8
PHLN-2N-SS-L3.0	1/8	76.2	11.1	4.8
PHLN-4N-SS-L1.5	1/4	38.1	14.3	7.1
PHLN-4N-SS-L2.0	1/4	50.8	14.3	7.1
PHLN-4N-SS-L2.5	1/4	63.5	14.3	7.1
PHLN-4N-SS-L3.0	1/4	76.2	14.3	7.1
PHLN-4N-SS-L4.0	1/4	101.6	14.3	7.1
PHLN-6N-SS-L1.5	3/8	38.1	17.5	9.7
PHLN-6N-SS-L2.0	3/8	50.8	17.5	9.7
PHLN-6N-SS-L2.5	3/8	63.5	17.5	9.7
PHLN-6N-SS-L3.0	3/8	76.2	17.5	9.7
PHLN-6N-SS-L4.0	3/8	101.6	17.5	9.7
PHLN-8N-SS-L2.0	1/2	50.8	22.2	11.9
PHLN-8N-SS-L3.0	1/2	76.2	22.2	11.9
PHLN-8N-SS-L4.0	1/2	101.6	22.2	11.9
PHLN-8N-SS-L6.0	1/2	152.4	22.2	11.9
PHLN-12N-SS-L2.0	3/4	50.8	27.0	15.7
PHLN-12N-SS-L3.0	3/4	76.2	27.0	15.7
PHLN-12N-SS-L4.0	3/4	101.6	27.0	15.7
PHLN-16N-SS-L3.0	1	76.2	34.9	22.4
PHLN-16N-SS-L4.0	1	101.6	34.9	22.4

Hex Long Nipples - ISO Tapered

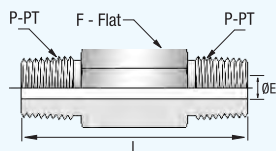

Part No	Pipe Size	Dimensions		
	P-PT, BSPT	L	F	E
PHLN-2R-SS-L1.5	1/8	38.1	11.1	4.8
PHLN-2R-SS-L2.0	1/8	50.8	11.1	4.8
PHLN-2R-SS-L2.5	1/8	63.5	11.1	4.8
PHLN-2R-SS-L3.0	1/8	76.2	11.1	4.8
PHLN-4R-SS-L1.5	1/4	38.1	14.3	7.1
PHLN-4R-SS-L2.0	1/4	50.8	14.3	7.1
PHLN-4R-SS-L2.5	1/4	63.5	14.3	7.1
PHLN-4R-SS-L3.0	1/4	76.2	14.3	7.1
PHLN-4R-SS-L4.0	1/4	101.6	14.3	7.1
PHLN-6R-SS-L1.5	3/8	38.1	17.5	9.7
PHLN-6R-SS-L2.0	3/8	50.8	17.5	9.7
PHLN-6R-SS-L2.5	3/8	63.5	17.5	9.7
PHLN-6R-SS-L3.0	3/8	76.2	17.5	9.7
PHLN-6R-SS-L4.0	3/8	101.6	17.5	9.7
PHLN-8R-SS-L2.0	1/2	50.8	22.2	11.9
PHLN-8R-SS-L3.0	1/2	76.2	22.2	11.9
PHLN-8R-SS-L4.0	1/2	101.6	22.2	11.9
PHLN-8R-SS-L6.0	1/2	152.4	22.2	11.9
PHLN-12R-SS-L2.0	3/4	50.8	27.0	15.7
PHLN-12R-SS-L3.0	3/4	76.2	27.0	15.7
PHLN-12R-SS-L4.0	3/4	101.6	27.0	15.7
PHLN-16R-SS-L3.0	1	76.2	34.9	22.4
PHLN-16R-SS-L4.0	1	101.6	34.9	22.4

Close Nipples - NPT

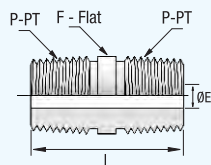
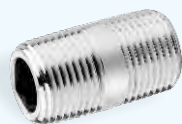

Part No	Pipe Size	Dimensions		
	P-PT, NPT	L	F	E
PCN-1N-SS	1/16	19.1	7.9	3.0
PCN-2N-SS	1/8	19.1	10.3	4.8
PCN-4N-SS	1/4	28.4	13.7	7.1
PCN-6N-SS	3/8	28.4	17.1	9.6
PCN-8N-SS	1/2	38.1	21.3	11.9
PCN-12N-SS	3/4	38.1	26.7	15.7
PCN-16N-SS	1	47.8	33.4	22.4

Instrumentation Pipe Fittings

Close Nipples - ISO Tapered

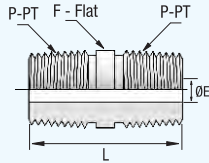

Part No	Pipe Size	Dimensions		
	P-PT, BSPT	L	F	E
PCN-1R-SS	1/16	19.1	7.9	3.0
PCN-2R-SS	1/8	19.1	10.3	4.8
PCN-4R-SS	1/4	28.4	13.7	7.1
PCN-6R-SS	3/8	28.4	17.1	9.7
PCN-8R-SS	1/2	38.1	21.3	11.9
PCN-12R-SS	3/4	38.1	26.7	15.7
PCN-16R-SS	1	47.8	33.4	22.4

Long Pipe Nipples - NPT

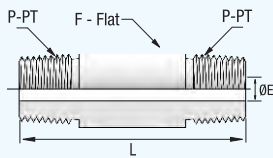

Part No	Pipe Size	Dimensions		
	P-PT, NPT	L	F	E
PLPN-2N-SS-L1.5	1/8	38.1	10.3	4.8
PLPN-2N-SS-L2.0	1/8	50.8	10.3	4.8
PLPN-2N-SS-L2.5	1/8	63.5	10.3	4.8
PLPN-2N-SS-L3.0	1/8	76.2	10.3	4.8
PLPN-4N-SS-L1.5	1/4	38.1	13.7	7.1
PLPN-4N-SS-L2.0	1/4	50.8	13.7	7.1
PLPN-4N-SS-L2.5	1/4	63.5	13.7	7.1
PLPN-4N-SS-L3.0	1/4	76.2	13.7	7.1
PLPN-4N-SS-L4.0	1/4	101.6	13.7	7.1
PLPN-6N-SS-L1.5	3/8	38.1	17.1	9.7
PLPN-6N-SS-L2.0	3/8	50.8	17.1	9.7
PLPN-6N-SS-L2.5	3/8	63.5	17.1	9.7
PLPN-6N-SS-L3.0	3/8	76.2	17.1	9.7
PLPN-6N-SS-L4.0	3/8	101.6	17.1	9.7
PLPN-8N-SS-L2.0	1/2	50.8	21.3	11.9
PLPN-8N-SS-L3.0	1/2	76.2	21.3	11.9
PLPN-8N-SS-L4.0	1/2	101.6	21.3	11.9
PLPN-8N-SS-L6.0	1/2	152.4	21.3	11.9
PLPN-12N-SS-L2.0	3/4	50.8	26.7	15.7
PLPN-12N-SS-L3.0	3/4	76.2	26.7	15.7
PLPN-12N-SS-L4.0	3/4	101.6	26.7	15.7
PLPN-16N-SS-L3.0	1	76.2	33.4	22.4
PLPN-16N-SS-L4.0	1	101.6	33.4	22.4

Instrumentation Pipe Fittings

Hex Couplings - NPT

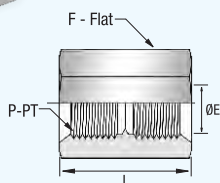

Part No	Pipe Size	Dimensions		
	P-PT, NPT	L	F	E
PHC-1N-SS	1/16	19.8	11.1	4.8
PHC-2N-SS	1/8	20.6	14.3	8.6
PHC-4N-SS	1/4	30.2	19.1	11.4
PHC-6N-SS	3/8	33.3	22.2	15.0
PHC-8N-SS	1/2	39.6	27.0	18.5
PHC-12N-SS	3/4	41.1	33.3	23.9
PHC-16N-SS	1	50.8	41.3	29.7

Hex Couplings - ISO Tapered

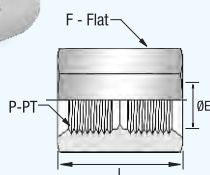
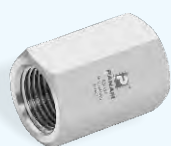

Part No	Pipe Size	Dimensions		
	P-PT, BSPT	L	F	E
PHC-2R-SS	1/8	20.6	14.3	8.4
PHC-4R-SS	1/4	30.2	19.1	11.2
PHC-6R-SS	3/8	33.3	22.2	14.7
PHC-8R-SS	1/2	39.6	27.0	18.3

Hex Couplings - ISO Parallel

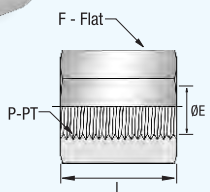

Part No	Pipe Size	Dimensions		
	P-PT, BSPP	L	F	E
PHC-1G-SS	1/16	19.8	11.1	4.8
PHC-2G-SS	1/8	20.6	14.3	8.6
PHC-4G-SS	1/4	30.2	19.1	11.4
PHC-6G-SS	3/8	33.3	22.2	15.0
PHC-8G-SS	1/2	39.6	27.0	18.5
PHC-12G-SS	3/4	41.1	33.3	23.9
PHC-16G-SS	1	50.8	41.3	29.7

Reducing Hex Couplings - NPT

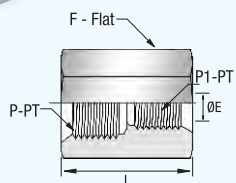

Part No	Pipe Size		Dimensions		
	P-PT, NPT	P1-PT, NPT	L	F	E
PRHC-4N-2N-SS	1/4	1/8	31.0	19.1	8.6
PRHC-6N-4N-SS	3/8	1/4	35.1	22.2	11.4
PRHC-8N-2N-SS	1/2	1/8	39.6	27.0	8.6
PRHC-8N-4N-SS	1/2	1/4	44.4	27.0	11.4
PRHC-8N-6N-SS	1/2	3/8	45.2	27.0	15.0
PRHC-12N-4N-SS	3/4	1/4	46.0	33.3	11.4
PRHC-12N-8N-SS	3/4	1/2	52.3	33.3	18.5
PRHC-16N-8N-SS	1	1/2	55.6	41.3	18.5
PRHC-16N-12N-SS	1	3/4	57.2	41.3	23.9

Instrumentation Pipe Fittings

Adapters - NPT

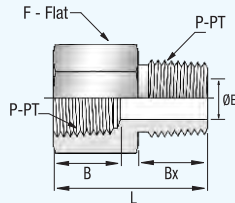

Part No	Pipe Size		Dimensions				
	P-PT, NPT		L	F	B	Bx	E
PA-2N-SS	1/8		27.9	14.3	10.4	9.7	4.8
PA-4N-SS	1/4		35.6	19.1	15.0	14.2	7.1
PA-6N-SS	3/8		38.4	22.2	15.0	14.2	9.6
PA-8N-SS	1/2		49.3	27.0	19.8	19.1	11.9
PA-12N-SS	3/4		51.3	33.3	20.6	19.1	15.7
PA-16N-SS	1		57.9	41.3	25.4	23.9	22.4

Adapters - NPT x ISO Tapered

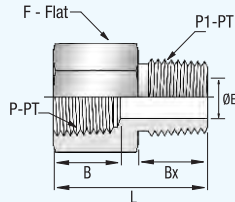

Part No	Pipe Size		Dimensions				
	P-PT, NPT	P1-PT, BSPT	L	F	B	Bx	E
PA-2N-2R-SS	1/8	1/8	27.7	14.3	10.4	9.7	4.8
PA-4N-4R-SS	1/4	1/4	36.1	19.1	15.0	14.2	7.1
PA-6N-6R-SS	3/8	3/8	38.1	22.2	15.0	14.2	9.6
PA-8N-8R-SS	1/2	1/2	49.3	27.0	19.8	19.1	11.9
PA-12N-12R-SS	3/4	3/4	51.3	33.3	20.6	19.1	15.7
PA-16N-16R-SS	1	1	58.4	41.3	25.4	23.9	22.4

Adapters - ISO Parallel

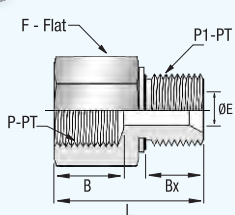

Part No	Pipe Size		Dimensions				
	P-PT, BSPP	P1-PT, BSPP	L	F	B	Bx	E
PA-2G-SS	1/8	1/8	27.1	14.0	10.4	7.1	3.5
PA-4G-SS	1/4	1/4	37.1	22.0	15.0	11.2	4.7
PA-6G-SS	3/8	3/8	36.9	23.0	15.0	11.2	7.9
PA-8G-SS	1/2	1/2	45.3	30.0	19.8	14.2	7.9
PA-12G-SS	3/4	3/4	47.3	32.0	20.6	15.7	11.1
PA-16G-SS	1	1	52.2	41.0	25.4	18.3	16.7

Adapters - NPT x ISO Parallel

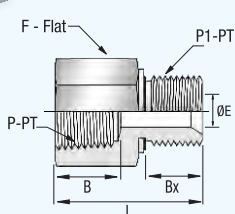

Part No	Pipe Size		Dimensions				
	P-PT, NPT	P1-PT, BSPP	L	F	B	Bx	E
PA-2N-2G-SS	1/8	1/8	25.1	14.3	9.9	7.1	4.1
PA-4N-4G-SS	1/4	1/4	33.5	19.1	10.4	11.2	5.8
PA-6N-6G-SS	3/8	3/8	35.8	22.2	15.0	11.2	7.9
PA-8N-8G-SS	1/2	1/2	44.2	27.0	15.0	14.2	11.9
PA-12N-12G-SS	3/4	3/4	48.0	33.3	20.6	15.7	15.7
PA-16N-16G-SS	1	1	53.3	41.3	25.4	18.3	19.8

Instrumentation Pipe Fittings

Adapters - ISO Tapered

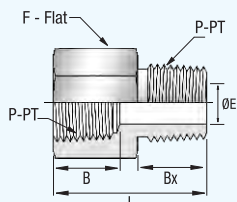

Part No	Pipe Size		Dimensions				
	P-PT, BSPT		L	F	B	Bx	E
PA-2R-SS	1/8		27.7	14.3	10.4	9.7	4.8
PA-4R-SS	1/4		36.1	19.1	15.0	14.2	7.1
PA-6R-SS	3/8		38.1	22.2	15.0	14.2	9.7
PA-8R-SS	1/2		49.5	27.0	19.8	19.1	11.9
PA-12R-SS	3/4		51.3	33.3	20.6	19.1	15.7
PA-16R-SS	1		58.4	41.3	25.4	23.9	22.4

Adapters - ISO Tapered x NPT

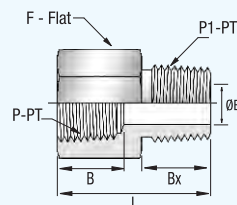

Part No	Pipe Size		Dimensions				
	P-PT, BSPT	P1-PT, NPT	L	F	B	Bx	E
PA-2R-2N-SS	1/8	1/8	27.7	14.3	10.4	9.7	4.8
PA-4R-4N-SS	1/4	1/4	36.3	19.1	15.0	14.2	7.1
PA-6R-6N-SS	3/8	3/8	38.4	22.2	15.0	14.2	9.6
PA-8R-8N-SS	1/2	1/2	49.8	27.0	19.8	19.1	11.9
PA-12R-12N-SS	3/4	3/4	51.3	33.3	20.6	19.1	15.7
PA-16R-16N-SS	1	1	58.4	41.3	25.4	23.9	22.4

Adapters - NPT x SAE / MS Straight

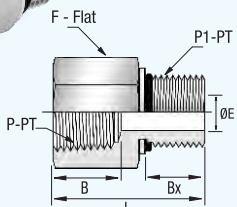

Part No	Pipe Size		Dimensions				
	P-PT, NPT	P1-PT, SAE	L	F	B	Bx	E
PA-4N-7S-SS	1/4	7/16-20	33.5	19.1	15.0	9.1	5.1
PA-6N-9S-SS	3/8	9/16-18	35.3	23.8	15.0	9.9	7.1
PA-8N-12S-SS	1/2	3/4-16	44.7	27.0	19.8	11.2	10.7
PA-12N-17S-SS	3/4	1 1/16-12	50.5	34.9	20.6	15.0	16.8
PA-16N-21S-SS	1	1 5/16-12	53.8	41.3	25.4	15.0	21.5

Adapters - ISO Parallel x NPT

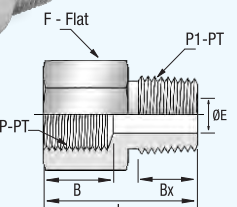

Part No	Pipe Size		Dimensions				
	P-PT, BSPP	P1-PT, NPT	L	F	B	Bx	E
PA-2G-2N-SS	1/8	1/8	21.8	14.3	6.5	9.7	4.5
PA-4G-4N-SS	1/4	1/4	30.2	19.1	12.9	14.2	5.5
PA-6G-6N-SS	3/8	3/8	32.2	23.8	14.2	14.2	6.5
PA-8G-8N-SS	1/2	1/2	42.7	27.0	18.8	19.1	7.0

Instrumentation Pipe Fittings

Reducing Adapters - NPT

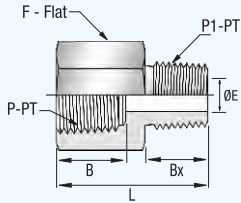

Part No	Pipe Size		Dimensions				
	P-PT, NPT	P1-PT, NPT	L	F	B	Bx	E
PRA-2N-1N-SS	1/8	1/16	27.7	14.3	10.4	9.7	3.0
PRA-4N-1N-SS	1/4	1/16	30.5	19.1	15.0	9.7	3.0
PRA-4N-2N-SS	1/4	1/8	32.0	19.1	15.0	9.7	4.8
PRA-6N-1N-SS	3/8	1/16	31.8	22.2	15.0	9.7	3.0
PRA-6N-2N-SS	3/8	1/8	33.8	22.2	15.0	9.7	4.8
PRA-6N-4N-SS	3/8	1/4	38.1	22.2	15.0	14.2	7.1
PRA-8N-2N-SS	1/2	1/8	40.0	27.0	19.8	9.7	4.8
PRA-8N-4N-SS	1/2	1/4	44.7	27.0	19.8	14.2	7.1
PRA-8N-6N-SS	1/2	3/8	44.4	27.0	19.8	14.2	9.6
PRA12N-2N-SS	3/4	1/8	39.6	33.3	20.6	9.7	4.8
PRA-12N-4N-SS	3/4	1/4	47.0	33.3	20.6	14.2	7.1
PRA-12N-6N-SS	3/4	3/8	46.2	33.3	20.6	14.2	9.6
PRA-12N-8N-SS	3/4	1/2	51.3	33.3	20.6	19.1	11.9
PRA-16N-2N-SS	1	1/8	46.0	41.3	25.4	9.7	4.8
PRA-16N-4N-SS	1	1/4	49.8	41.3	25.4	14.2	7.1
PRA-16N-6N-SS	1	3/8	50.8	41.3	25.4	14.2	9.6
PRA-16N-8N-SS	1	1/2	54.9	41.3	25.4	19.1	11.9
PRA-16N-12N-SS	1	3/4	55.1	41.3	25.4	19.1	15.7
PRA-20N-12N-SS	1 1/4	1	62.7	54.0	25.4	23.9	22.4

Reducing Adapters - ISO Tapered

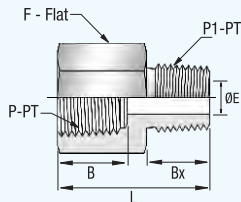

Part No	Pipe Size		Dimensions				
	P-PT, BSPT	P1-PT, BSPT	L	F	B	Bx	E
PRA-4R-2R-SS	1/4	1/8	32.0	19.1	15.0	9.7	4.8
PRA-6R-4R-SS	3/8	1/4	38.1	22.2	15.0	14.2	7.1
PRA-8R-4R-SS	1/2	1/4	44.7	27.0	19.8	14.2	7.1
PRA-8R-6R-SS	1/2	3/8	44.4	27.0	19.8	14.2	9.7

Instrumentation Pipe Fittings

Reducing Adapters - ISO Parallel

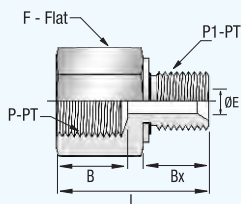

Part No	Pipe Size		Dimensions				
	P-PT, BSPP	P1-PT, BSPP	L	F	B	Bx	E
PRA-6G-4G-SS	3/8	1/4	37.1	22.0	15.0	11.0	4.7
PRA-8G-4G-SS	1/2	1/4	38.0	27.0	19.8	11.0	4.7
PRA-8G-6G-SS	1/2	3/8	45.3	30.0	19.8	12.0	7.9
PRA-12G-4G-SS	3/4	1/4	40.0	32.0	20.6	11.0	4.7
PRA-12G-6G-SS	3/4	3/8	41.6	32.0	20.6	12.0	7.9
PRA-12G-8G-SS	3/4	1/2	47.3	32.0	20.6	14.0	11.1
PRA-16G-4G-SS	1	1/4	43.0	41.0	25.4	11.0	4.7
PRA-16G-6G-SS	1	3/8	44.6	41.0	25.4	12.0	7.9
PRA-16G-8G-SS	1	1/2	50.3	41.0	25.4	14.0	11.1
PRA-16G-12G-SS	1	3/4	52.2	41.0	25.4	16.0	16.7

Reducing Bushings - NPT

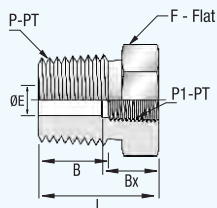

Part No	Pipe Size		Dimensions				
	P-PT, NPT	P1-PT, NPT	L	F	B	Bx	E
PRB-2N-1N-SS	1/8	1/16	26.2	11.1	9.7	9.9	4.8
PRB-4N-1N-SS	1/4	1/16	21.8	14.3	14.2	9.9	4.8
PRB-4N-2N-SS	1/4	1/8	26.9	14.3	14.2	10.4	7.1
PRB-6N-1N-SS	3/8	1/16	21.8	17.5	14.2	9.9	4.8
PRB-6N-2N-SS	3/8	1/8	21.8	17.5	14.2	10.4	7.1
PRB-6N-4N-SS	3/8	1/4	30.2	19.1	14.2	15.0	9.7
PRB-8N-2N-SS	1/2	1/8	27.4	22.2	19.1	10.4	7.1
PRB-8N-4N-SS	1/2	1/4	27.4	22.2	19.1	15.0	10.4
PRB-8N-6N-SS	1/2	3/8	35.8	22.2	19.1	15.0	11.9
PRB-12N-2N-SS	3/4	1/8	27.4	27.0	19.1	10.4	7.1
PRB-12N-4N-SS	3/4	1/4	27.4	27.0	19.1	15.0	10.4
PRB-12N-6N-SS	3/4	3/8	27.4	27.0	19.1	15.0	12.7
PRB-12N-8N-SS	3/4	1/2	41.4	27.0	19.1	19.8	15.7
PRB-16N-2N-SS	1	1/8	34.5	34.9	23.9	10.4	7.1
PRB-16N-4N-SS	1	1/4	34.8	34.9	23.9	15.0	10.4
PRB-16N-6N-SS	1	3/8	34.8	34.9	23.9	15.0	12.7
PRB-16N-8N-SS	1	1/2	34.8	34.9	23.9	19.8	15.7
PRB-16N-12N-SS	1	3/4	47.0	34.9	23.9	20.6	22.4

Instrumentation Pipe Fittings

Reducing Bushings - NPT x ISO Tapered

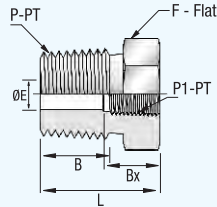

Part No	Pipe Size		Dimensions				
	P-PT, NPT	P1-PT, BSPT	L	F	B	Bx	E
PRB-2N-1R-SS	1/8	1/16	26.2	11.1	9.7	9.9	4.8
PRB-4N-1R-SS	1/4	1/16	21.8	14.3	14.2	9.9	4.8
PRB-4N-2R-SS	1/4	1/8	26.9	14.3	14.2	10.4	7.1
PRB-6N-1R-SS	3/8	1/16	21.8	17.5	14.2	9.9	4.8
PRB-6N-2R-SS	3/8	1/8	21.8	17.5	14.2	10.4	7.1
PRB-6N-4R-SS	3/8	1/4	30.2	19.1	14.2	15.0	9.7
PRB-8N-2R-SS	1/2	1/8	27.4	22.2	19.1	10.4	7.1
PRB-8N-4R-SS	1/2	1/4	27.4	22.2	19.1	15.0	10.4
PRB-8N-6R-SS	1/2	3/8	35.8	22.2	19.1	15.0	11.9
PRB-12N-2R-SS	3/4	1/8	27.4	27.0	19.1	10.4	7.1
PRB-12N-4R-SS	3/4	1/4	27.4	27.0	19.1	15.0	10.4
PRB-12N-6R-SS	3/4	3/8	27.4	27.0	19.1	15.0	12.7
PRB-12N-8R-SS	3/4	1/2	41.4	27.0	19.1	19.8	15.7
PRB-16N-2R-SS	1	1/8	34.5	34.9	23.9	10.4	7.1
PRB-16N-4R-SS	1	1/4	34.8	34.9	23.9	15.0	10.4
PRB-16N-6R-SS	1	3/8	34.8	34.9	23.9	15.0	12.7
PRB-16N-8R-SS	1	1/2	34.8	34.9	23.9	19.8	15.7
PRB-16N-12R-SS	1	3/4	47.0	34.9	23.9	20.6	22.4

Reducing Bushing - SAE/ MS

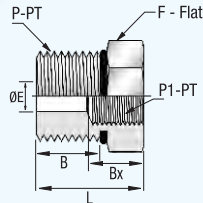

Part No	Pipe Size		Dimensions				
	P-PT, SAE	P1-PT, SAE	L	F	B	Bx	E
PRB-9S-7S-SS	9/16-18	7/16-20	28.4	20.6	9.9	14.0	7.1
PRB-12S-7S-SS	3/4-16	7/16-20	24.9	22.2	11.2	14.0	9.9
PRB-12S-9S-SS	3/4-16	9/16-18	30.2	25.4	11.2	16.0	10.7
PRB-7S-9S-SS	7/8-14	9/16-18	27.9	25.4	12.7	16.0	12.7
PRB-7S-12S-SS	7/8-14	3/4-16	36.1	30.2	12.7	18.0	12.7
PRB-17S-12S-SS	1 1/16-12	3/4-16	32.3	31.8	15.0	18.0	16.5
PRB-21S-17S-SS	1 5/16-12	1 1/16-12	40.9	41.3	15.0	24.0	22.1
PRB-26S-21S-SS	1 5/8-12	1 5/16-12	50.3	54.0	15.0	24.0	27.7
PRB-30S-21S-SS	1 7/8-12	1 5/16-12	50.3	54.0	15.0	24.0	31.2

Instrumentation Pipe Fittings

Hex Plugs - NPT

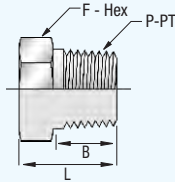

Part No	Pipe Size	Dimensions		
	P-PT, NPT	L	F	B
PHP-1N-SS	1/16	14.2	7.9	9.7
PHP-2N-SS	1/8	14.2	11.1	9.7
PHP-4N-SS	1/4	19.1	14.3	14.2
PHP-6N-SS	3/8	19.8	17.5	14.2
PHP-8N-SS	1/2	24.6	22.2	19.1
PHP-12N-SS	3/4	30.7	27.0	19.1
PHP-16N-SS	1	38.1	34.9	23.9
PHP-20N-SS	1 1/4	38.4	44.5	23.9
PHP-24N-SS	1 1/2	43.7	50.8	26.2
PHP-32N-SS	2	50.8	69.9	26.2

Hex Plugs - ISO Tapered

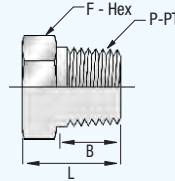

Part No	Pipe Size	Dimensions		
	P-PT, BSPT	L	F	B
PHP-1R-SS	1/16	14.2	7.9	9.7
PHP-2R-SS	1/8	14.2	11.1	9.7
PHP-4R-SS	1/4	19.1	14.3	14.2
PHP-6R-SS	3/8	19.8	17.5	14.2
PHP-8R-SS	1/2	24.6	22.2	19.1
PHP-12R-SS	3/4	30.7	27.0	19.1
PHP-16R-SS	1	38.1	34.9	23.9
PHP-20R-SS	1 1/4	38.4	44.5	23.9
PHP-24R-SS	1 1/2	43.7	50.8	26.2
PHP-32R-SS	2	50.8	69.9	26.2

Hex Plugs - ISO Parallel

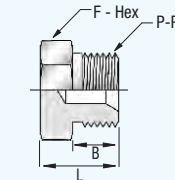

Part No	Pipe Size	Dimensions		
	P-PT, BSPP	L	F	B
PHP-2G-SS	1/8	14.3	14.0	8.0
PHP-4G-SS	1/4	18.8	19.0	11.0
PHP-6G-SS	3/8	20.5	22.0	12.0
PHP-8G-SS	1/2	24.0	27.0	14.0
PHP-12G-SS	5/8	24.0	30.0	16.0
PHP-16G-SS	3/4	26.5	32.0	16.0
PHP-16G-SS	1	30.2	41.0	19.0
PHP-16G-SS	1 1/4	38.7	50.0	20.0
PHP-16G-SS	1 1/2	42.7	55.0	22.0
PHP-32G-SS	2	48.2	70.0	25.0

Instrumentation Pipe Fittings

Hex Plugs - SAE/MS Straight

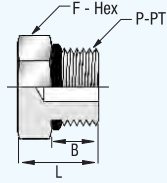

Part No	Pipe Size	Dimensions		
	P-PT, SAE	L	F	B
PHP-7S-SS	7/16-20	19.3	14.3	9.1
PHP-9S-SS	9/16-18	20.8	17.5	9.9
PHP-12S-SS	3/4-16	22.6	22.2	11.2
PHP-17S-SS	1 1/16-12	28.4	31.8	15.0
PHP-21S-SS	1 5/16-12	30.0	38.1	15.0

Hex Plugs - Metric

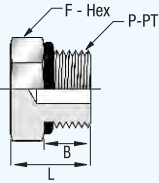

Part No	Pipe Size	Dimensions		
	P-PT, Metric	L	F	B
PHP-14M-SS	M14 x 1.5	21.0	20.6	12.0
PHP-16M-SS	M16 X1.5	23.0	22.2	12.0
PHP-18M-SS	M18 X 1.5	25.0	23.8	12.0
PHP-20M-SS	M20 X 1.5	26.5	25.4	14.0
PHP-22M-SS	M22 X 1.5	28.8	28.6	14.0
PHP-24M-SS	M24 X 1.5	29.0	35.0	14.0
PHP-27M-SS	M27 X 2	30.0	36.5	16.0

Hollow Hex Plugs - NPT

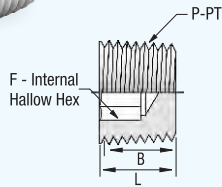
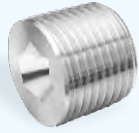

Part No	Pipe Size	Dimensions		
	P-PT, NPT	L	F	B
PHHP-1N-SS	1/16	7.6	4.0	7.4
PHHP-2N-SS	1/8	10.4	4.8	7.4
PHHP-4N-SS	1/4	15.5	6.4	12.4
PHHP-6N-SS	3/8	15.0	7.9	11.9
PHHP-8N-SS	1/2	19.3	9.5	16.2
PHHP-12N-SS	3/4	19.8	14.3	16.7
PHHP-16N-SS	1	20.8	15.9	17.7

Hollow Hex Plugs - ISO Tapered

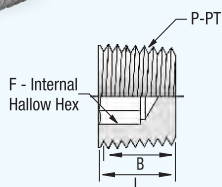
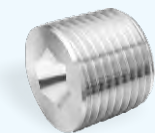

Part No	Pipe Size	Dimensions		
	P-PT, BSPT	L	F	B
PHHP-1R-SS	1/16	7.6	4.0	7.4
PHHP-2R-SS	1/8	10.4	4.8	7.4
PHHP-4R-SS	1/4	15.5	6.4	12.4
PHHP-6R-SS	3/8	15.5	7.9	12.4
PHHP-8R-SS	1/2	19.3	9.5	16.2
PHHP-12R-SS	3/4	19.8	14.3	16.7
PHHP-16R-SS	1	20.8	15.9	17.7

Instrumentation Pipe Fittings

Hollow Hex Plugs - SAE/MS Straight

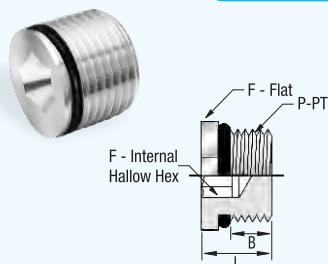

Part No	Pipe Size	Dimensions		
	P-PT, SAE	L	F	B
PHHP-7S-SS	7/16-20	11.4	14.2	9.1
PHHP-9S-SS	9/16-18	12.2	17.5	9.9
PHHP-12S-SS	3/4-16	14.2	22.4	11.2
PHHP-17S-SS	1 1/16-12	19.1	31.8	15.0
PHHP-21S-SS	1 5/16-12	19.1	38.1	15.0

Pipe Caps - NPT

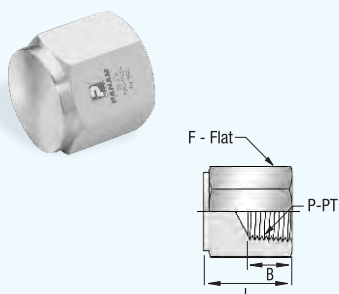

Part No	Pipe Size	Dimensions		
	P-PT, NPT	L	F	B
PPC-1N-SS	1/16	12.7	11.1	9.9
PPC-2N-SS	1/8	19.1	14.3	10.4
PPC-4N-SS	1/4	23.1	19.1	15.0
PPC-6N-SS	3/8	26.2	22.2	15.0
PPC-8N-SS	1/2	34.0	27.0	19.8
PPC-12N-SS	3/4	36.6	33.3	20.6
PPC-16N-SS	1	41.1	41.3	25.4

Union - NPT

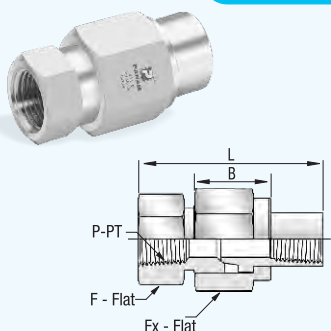

Part No	Pipe Size	Dimensions				
	P-PT, NPT	L	F	Fx	B	E
PU-2N-SS	1/8	46.0	23.8	28.6	10.4	6.8
PU-4N-SS	1/4	59.4	30.2	34.9	15.0	9.1
PU-6N-SS	3/8	63.5	33.3	38.1	15.0	13.2
PU-8N-SS	1/2	68.3	41.3	44.5	19.8	15.7
PU-12N-SS	3/4	79.2	47.6	54.0	20.6	22.4
PU-16N-SS	1	90.4	60.3	63.5	25.4	26.2

Union - ISO Tapered

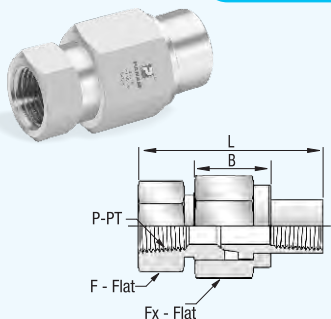

Part No	Pipe Size	Dimensions				
	P-PT, BSPT	L	F	Fx	B	E
PU-2R-SS	1/8	46.0	23.8	28.6	10.4	6.8
PU-4R-SS	1/4	59.4	30.2	34.9	15.0	9.1
PU-6N-SS	3/8	63.5	33.3	38.1	15.0	13.2
PU-8R-SS	1/2	68.3	41.3	44.5	19.8	15.7
PU-12R-SS	3/4	79.2	47.6	54.0	20.6	22.4
PU-16R-SS	1	90.4	60.3	63.5	25.4	26.2

Instrumentation Pipe Fittings

Female Elbow - NPT

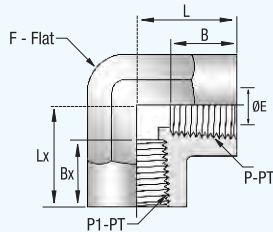

Part No	Pipe Size		Dimensions					
	P-PT, NPT	P1-PT, NPT	L	F	B	E	Lx	Bx
PFE-1N-SS	1/16	1/16	21.8	11.1	9.9	4.8	21.8	9.9
PFE-2N-1N-SS	1/8	1/16	26.4	12.7	10.4	4.8	26.4	9.9
PFE-2N-SS	1/8	1/8	26.4	12.7	10.4	7.1	26.4	10.4
PFE-4N-2N-SS	1/4	1/8	29.7	17.5	15.0	7.1	29.7	10.4
PFE-4N-SS	1/4	1/4	29.7	17.5	15.0	10.4	29.7	15.0
PFE-6N-SS	3/8	3/8	36.1	20.6	15.0	12.7	36.1	15.0
PFE-8N-SS	1/2	1/2	39.6	25.4	19.8	17.1	39.6	19.8
PFE-12N-SS	3/4	3/4	48.8	31.8	20.6	22.4	48.8	20.6
PFE-16N-SS	1	1	48.5	42.9	25.4	28.1	48.5	25.4
PFE-20N-SS	1 1/4	1 1/4	59.8	50.8	25.4	27.7	59.8	25.4
PFE-24N-SS	1 1/2	1 1/2	65.0	63.5	27.7	34.0	65.0	27.7

Female Elbow - ISO Tapered

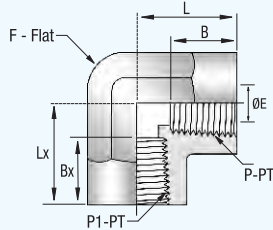

Part No	Pipe Size		Dimensions					
	P-PT, BSPT	P1-PT, BSPT	L	F	B	E	Lx	Bx
PFE-1R-SS	1/16	1/16	21.8	11.1	9.9	4.8	21.8	9.9
PFE-2R-1R-SS	1/8	1/16	26.4	12.7	10.4	4.8	26.4	9.9
PFE-2R-SS	1/8	1/8	26.4	12.7	10.4	7.1	26.4	10.4
PFE-4R-2R-SS	1/4	1/8	29.7	17.5	15.0	7.1	29.7	10.4
PFE-4R-SS	1/4	1/4	29.7	17.5	15.0	10.4	29.7	15.0
PFE-6R-SS	3/8	3/8	36.1	20.6	15.0	12.7	36.1	15.0
PFE-8R-SS	1/2	1/2	39.6	25.4	19.8	17.1	39.6	19.8
PFE-12R-SS	3/4	3/4	48.8	31.8	20.6	22.4	48.8	20.6
PFE-16R-SS	1	1	48.5	42.9	25.4	28.1	48.5	25.4
PFE-20R-SS	1 1/4	1 1/4	59.8	50.8	25.4	27.7	59.8	25.4
PFE-24R-SS	1 1/2	1 1/2	65.0	63.5	27.7	34.0	65.0	27.7

Female Elbow - ISO Parallel

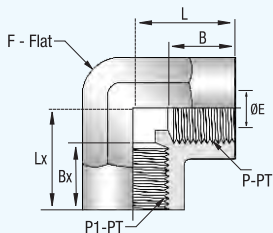
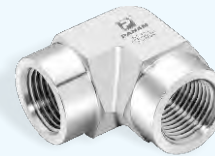

Part No	Pipe Size		Dimensions					
	P-PT, BSPP	P1-PT, BSPP	L	F	B	E	Lx	Bx
PFE-1G-SS	1/16	1/16	21.8	11.1	9.9	4.8	21.8	9.9
PFE-2G-1G-SS	1/8	1/16	26.4	12.7	10.4	4.8	26.4	9.9
PFE-2G-SS	1/8	1/8	26.4	12.7	10.4	7.1	26.4	10.4
PFE-4G-2G-SS	1/4	1/8	29.7	17.5	15.0	7.1	29.7	10.4
PFE-4G-SS	1/4	1/4	29.7	17.5	15.0	10.4	29.7	15.0
PFE-6G-SS	3/8	3/8	36.1	20.6	15.0	12.7	36.1	15.0
PFE-8G-SS	1/2	1/2	39.6	25.4	19.8	17.1	39.6	19.8
PFE-12G-SS	3/4	3/4	48.8	31.8	20.6	22.4	48.8	20.6
PFE-16G-SS	1	1	48.5	42.9	25.4	28.1	48.5	25.4
PFE-20G-SS	1 1/4	1 1/4	59.8	50.8	25.4	27.7	59.8	25.4
PFE-24G-SS	1 1/2	1 1/2	65.0	63.5	27.7	34.0	65.0	27.7

Instrumentation Pipe Fittings

Male Elbow - NPT

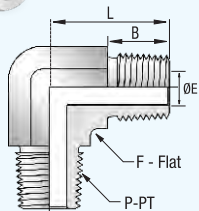

Part No	Pipe Size	Dimensions			
	P-PT, NPT	L	F	B	E
PME-1N-SS	1/16	18.3	9.5	9.7	3.0
PME-2N-SS	1/8	22.4	11.1	9.7	4.8
PME-4N-SS	1/4	26.7	12.7	14.2	7.1
PME-6N-SS	3/8	29.7	17.5	14.2	9.6
PME-8N-SS	1/2	36.8	20.6	19.1	11.9
PME-12N-SS	3/4	40.4	27.0	19.1	15.7
PME-16N-SS	1	50.0	34.9	23.9	22.4

Male Elbow - ISO Tapered

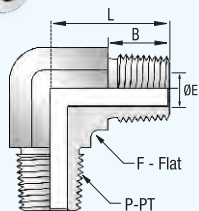

Part No	Pipe Size	Dimensions			
	P-PT, BSPT	L	F	B	E
PME-1R-SS	1/16	18.3	9.5	9.7	3.0
PME-2R-SS	1/8	22.4	11.1	9.7	4.8
PME-4R-SS	1/4	26.7	12.7	14.2	7.1
PME-6R-SS	3/8	29.7	17.5	14.2	9.6
PME-8R-SS	1/2	36.8	20.6	19.1	11.9
PME-12R-SS	3/4	40.4	27.0	19.1	15.7
PME-16R-SS	1	50.0	34.9	23.9	22.4

Male Elbow - ISO Parallel

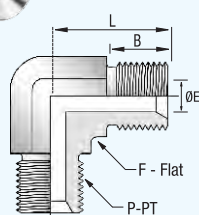

Part No	Pipe Size	Dimensions			
	P-PT, BSPP	L	F	B	E
PME-1G-SS	1/8	16.6	11.0	8.0	3.5
PME-2G-SS	1/4	27.8	14.0	11.0	4.7
PME-4G-SS	3/8	31.7	19.0	12.0	7.9
PME-6G-SS	1/2	37.0	22.0	14.0	11.1
PME-8G-SS	5/8	39.0	22.0	16.0	14.3
PME-12G-SS	3/4	41.6	27.0	16.0	16.7
PME-16G-SS	1	49.7	23.0	19.0	22.2

Instrumentation Pipe Fittings

Swivel Male Elbow

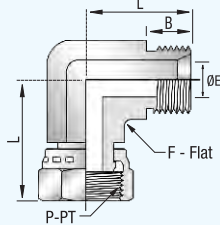

Part No	Pipe Size	Dimensions				
	P-PT, BSPP	L	L1	F	B	E
PME-2G-SWL-SS	1/8	16.6	22.0	11.0	8.0	3.5
PME-4G-SWL-SS	1/4	27.8	31.2	19.0	11.0	4.7
PME-6G-SWL-SS	3/8	31.7	36.2	22.0	12.0	7.9
PME-8G-SWL-SS	1/2	37.0	41.0	27.0	14.0	11.1
PME-10G-SWL-SS	5/8	39.0	41.6	27.0	16.0	14.3
PME-12G-SWL-SS	3/4	41.6	45.3	33.0	16.0	16.7
PME-16G-SWL-SS	1	49.7	53.9	41.0	19.0	22.2
PME-20G-SWL-SS	1 1/4	54.4	60.0	48.0	20.0	28.6
PME-24G-SWL-SS	1 1/2	53.7	63.3	48.0	22.0	33.3

Swivel Union Elbow

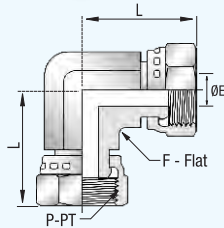

Part No	Pipe Size	Dimensions		
	P-PT, BSPP	F	L	E
PUE-4G-SWL-SS	1/4	14.0	30.5	4.7
PUE-6G-SWL-SS	3/8	19.0	33.0	7.9
PUE-8G-SWL-SS	1/2	22.0	38.8	11.1
PUE-10G-SWL-SS	5/8	22.0	39.4	14.3
PUE-12G-SWL-SS	3/4	27.0	42.3	16.7
PUE-16G-SWL-SS	1	33.0	49.0	22.2
PUE-20G-SWL-SS	1 1/4	41.0	58.2	28.6
PUE-24G-SWL-SS	1 1/2	48.0	63.3	33.3

Street Elbow - NPT

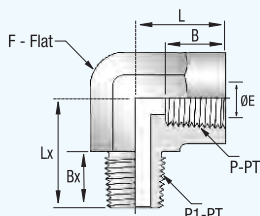

Part No	Pipe Size		Dimensions					
	P-PT, NPT	P1-PT, NPT	L	F	B	E	Lx	Bx
PSE-1N-SS	1/16	1/16	21.8	11.1	9.9	3.0	22.4	9.7
PSE-1N-2N-SS	1/16	1/8	21.8	11.1	9.9	4.8	22.4	9.7
PSE-1N-4N-SS	1/16	1/4	22.4	14.3	9.9	4.8	27.7	14.2
PSE-1N-6N-SS	1/16	3/8	22.4	17.5	9.9	4.8	29.7	14.2
PSE-2N-1N-SS	1/8	1/16	26.4	12.7	10.4	3.0	22.1	9.7
PSE-2N-SS	1/8	1/8	26.4	12.7	10.4	4.8	22.1	9.7
PSE-2N-4N-SS	1/8	1/4	22.4	14.3	10.4	7.1	27.7	14.2
PSE-2N-6N-SS	1/8	3/8	22.4	17.5	10.4	7.1	29.7	14.2
PSE-2N-8N-SS	1/8	1/2	24.1	20.6	10.4	7.1	36.8	19.1
PSE-2N-12N-SS	1/8	3/4	25.4	27.0	10.4	7.1	40.4	19.1
PSE-2N-16N-SS	1/8	1	26.4	34.9	10.4	7.1	50.0	23.9
PSE-4N-2N-SS	1/4	1/8	29.7	17.5	15.0	4.8	25.4	9.7
PSE-4N-SS	1/4	1/4	29.7	17.5	15.0	7.1	29.7	14.2
PSE-4N-6N-SS	1/4	3/8	29.7	17.5	15.0	8.6	29.7	14.2
PSE-4N-8N-SS	1/4	1/2	25.4	20.6	15.0	8.6	36.8	19.1
PSE-4N-12N-SS	1/4	3/4	25.4	27.0	15.0	8.6	40.4	19.1
PSE-4N-16N-SS	1/4	1	41.4	34.9	15.0	8.6	50.0	23.9
PSE-6N-4N-SS	3/8	1/4	36.1	20.6	15.0	7.1	32.0	14.2
PSE-6N-SS	3/8	3/8	36.1	20.6	15.0	9.6	32.0	14.2
PSE-6N-8N-SS	3/8	1/2	36.1	20.6	15.0	11.9	36.8	19.1
PSE-6N-12N-SS	3/8	3/4	31.2	27.0	15.0	11.9	40.4	19.1
PSE-6N-16N-SS	3/8	1	41.4	34.9	15.0	11.9	50.0	23.9
PSE-8N-4N-SS	1/2	1/4	39.6	25.4	19.8	7.1	35.1	14.2
PSE-8N-6N-SS	1/2	3/8	39.6	25.4	19.8	9.6	35.1	14.2
PSE-8N-SS	1/2	1/2	39.6	25.4	19.8	11.9	39.6	19.1
PSE-8N-12N-SS	1/2	3/4	31.2	27.0	19.8	15.7	40.4	19.1
PSE-8N-16N-SS	1/2	1	41.4	34.9	19.8	15.7	50.0	23.9
PSE-12N-SS	3/4	3/4	48.8	31.8	20.6	15.7	42.4	19.1
PSE-12N-16N-SS	3/4	1	41.4	34.9	20.6	22.4	50.0	23.9
PSE-16N-SS	1	1	48.5	42.9	25.4	22.4	49.3	23.9
PSE-20N-SS	1 1/4	1 1/4	60.5	50.8	25.4	31.8	60.5	23.9

Instrumentation Pipe Fittings

Female Tee - NPT

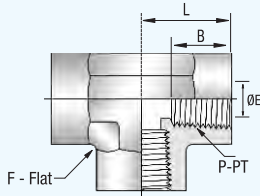

Part No	Pipe Size	Dimensions			
	P-PT, NPT	L	F	B	E
PFT-1N-SS	1/16	21.8	11.1	9.9	4.8
PFT-2N-SS	1/8	26.4	12.7	10.4	8.6
PFT-4N-SS	1/4	29.7	17.5	15.0	11.4
PFT-6N-SS	3/8	36.1	20.6	15.0	15.0
PFT-8N-SS	1/2	39.6	25.4	19.8	18.5
PFT-12N-SS	3/4	48.8	31.8	20.6	23.9
PFT-16N-SS	1	48.5	42.9	25.4	29.7
PFT-20N-SS	1 1/4	59.8	50.8	25.4	37.2
PFT-24N-SS	1 1/2	65.0	63.5	27.7	43.3

Female Tee - ISO Parallel

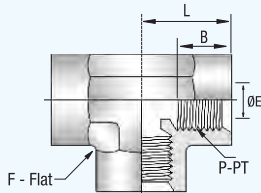

Part No	Pipe Size	Dimensions			
	P-PT, BSPP	L	F	B	E
PFT-1G-SS	1/16	21.8	11.1	9.9	4.8
PFT-2G-SS	1/8	26.4	12.7	10.4	8.6
PFT-4G-SS	1/4	29.7	17.5	15.0	11.4
PFT-6G-SS	3/8	36.1	20.6	15.0	15.0
PFT-8G-SS	1/2	39.6	25.4	19.8	18.5
PFT-12G-SS	3/4	48.8	31.8	20.6	23.9
PFT-16G-SS	1	48.5	42.9	25.4	29.7
PFT-20G-SS	1 1/4	59.8	50.8	25.4	37.2
PFT-24G-SS	1 1/2	65.0	63.5	27.7	43.3

Male Tee - NPT

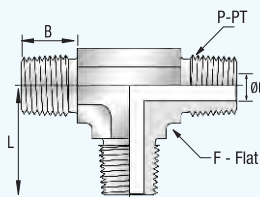

Part No	Pipe Size	Dimensions			
	P-PT, NPT	L	F	B	E
PMT-1N-SS	1/16	18.3	9.5	9.7	3.0
PMT-2N-SS	1/8	22.4	11.1	9.7	4.8
PMT-4N-SS	1/4	26.7	12.7	14.2	7.1
PMT-6N-SS	3/8	29.7	17.5	14.2	9.6
PMT-8N-SS	1/2	36.8	20.6	19.1	11.9
PMT-12N-SS	3/4	42.4	27.0	19.1	15.7
PMT-16N-SS	1	49.3	34.9	23.9	22.4
PMT-20N-SS	1 1/4	56.4	42.9	23.9	27.7
PMT-24N-SS	1 1/2	67.1	47.6	26.2	34.0

Instrumentation Pipe Fittings

Male Tee - ISO Parallel

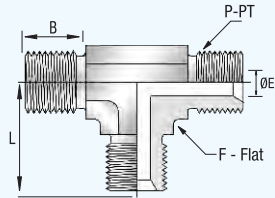

Part No	Pipe Size	Dimensions			
	P-PT, BSPP	L	F	B	E
PMT-2G-SS	1/8	16.6	11.0	8.0	3.5
PMT-4G-SS	1/4	27.8	19.0	11.0	4.7
PMT-6G-SS	3/8	31.7	22.0	12.0	7.9
PMT-8G-SS	1/2	37.0	27.0	14.0	11.1
PMT-10G-SS	5/8	39.0	27.0	16.0	14.3
PMT-12G-SS	3/4	41.9	33.0	16.0	16.7
PMT-16G-SS	1	49.7	41.0	19.0	22.2
PMT-20G-SS	1 1/4	54.4	48.0	20.0	28.6
PMT-24G-SS	1 1/2	53.7	48.0	22.0	33.3

Female Branch Tee - NPT

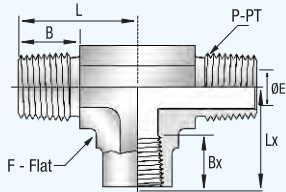

Part No	Pipe Size	Dimensions					
	P-PT, NPT	L	F	B	E	Lx	Bx
PFBT-1N-SS	1/16	18.3	11.1	9.7	3.0	21.8	9.9
PFBT-2N-SS	1/8	22.1	12.7	9.7	4.8	26.4	10.4
PFBT-4N-SS	1/4	29.7	17.5	14.2	7.1	29.7	15.0
PFBT-6N-SS	3/8	32.0	20.6	14.2	9.6	36.1	15.0
PFBT-8N-SS	1/2	39.6	25.4	19.1	11.9	39.6	19.8
PFBT-12N-SS	3/4	42.4	31.8	19.1	15.7	48.8	20.6
PFBT-16N-SS	1	49.3	42.9	23.9	22.4	48.5	25.4

Female Run Tee - NPT

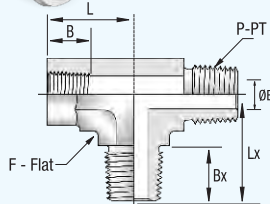

Part No	Pipe Size	Dimensions					
	P-PT, NPT	L	F	B	E	Lx	Bx
PFRT-1N-SS	1/16	21.8	11.1	9.9	3.0	18.3	9.7
PFRT-2N-SS	1/8	26.4	12.7	10.4	4.8	22.1	9.7
PFRT-4N-SS	1/4	29.7	17.5	15.0	7.1	29.7	14.2
PFRT-6N-SS	3/8	36.1	20.6	15.0	9.6	32.0	14.2
PFRT-8N-SS	1/2	39.6	25.4	19.8	11.9	39.6	19.1
PFRT-12N-SS	3/4	48.8	31.8	20.6	15.7	42.4	19.1
PFRT-16N-SS	1	48.5	42.9	25.4	22.4	49.3	23.9

Instrumentation Pipe Fittings

Street Tee - NPT

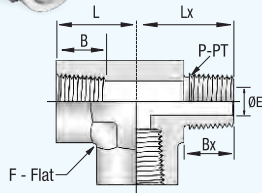

Part No	Pipe Size	Dimensions					
	P-PT, NPT	L	F	B	E	Lx	Bx
PST-1N-SS	1/16	21.8	11.1	9.9	3.0	18.3	9.7
PST-2N-SS	1/8	26.4	12.7	10.4	4.8	22.1	9.7
PST-4N-SS	1/4	29.7	17.5	15.0	7.1	29.7	14.2
PST-6N-SS	3/8	36.1	20.6	15.0	9.6	32.0	14.2
PST-8N-SS	1/2	39.6	25.4	19.8	11.9	39.6	19.1
PST-12N-SS	3/4	48.8	31.8	20.6	15.7	42.4	19.1
PST-16N-SS	1	48.5	42.9	25.4	22.4	49.3	23.9

Branch Tee - NPT

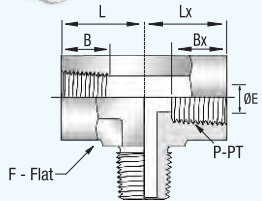

Part No	Pipe Size	Dimensions					
	P-PT, NPT	L	F	B	E	Lx	Bx
PBT-1N-SS	1/16	21.8	11.1	9.9	3.0	18.3	9.7
PBT-2N-SS	1/8	26.4	12.7	10.4	4.8	22.1	9.7
PBT-4N-SS	1/4	29.7	17.5	15.0	7.1	29.7	14.2
PBT-6N-SS	3/8	36.1	20.6	15.0	9.6	32.0	14.2
PBT-8N-SS	1/2	39.6	25.4	19.8	11.9	39.6	19.1
PBT-12N-SS	3/4	48.8	31.8	20.6	15.7	42.4	19.1
PBT-16N-SS	1	48.5	42.9	25.4	22.4	49.3	23.9

Swivel Branch Tee

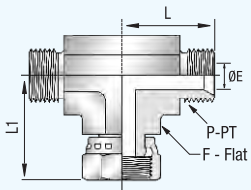

Part No	Pipe Size	Dimensions			
	P-PT, BSPP	L	L1	F	E
PBT-2G-SWL-SS	1/8	16.6	22.0	11.0	3.5
PBT-4G-SWL-SS	1/4	27.8	31.2	19.0	4.7
PBT-6G-SWL-SS	3/8	31.7	36.2	27.0	7.9
PBT-8G-SWL-SS	1/2	37.0	41.0	27.0	11.1
PBT-10G-SWL-SS	5/8	39.0	41.6	27.0	14.3
PBT-12G-SWL-SS	3/4	41.6	45.3	33.0	16.7
PBT-16G-SWL-SS	1	49.7	53.9	41.0	22.2
PBT-20G-SWL-SS	1 1/4	54.4	60.0	48.0	28.6

Instrumentation Pipe Fittings

Swivel Run Tee

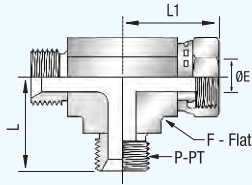

Part No	Pipe Size	Dimensions			
	P-PT, BSPP	L	L1	F	E
PRT-2G-SWL-SS	1/8	16.6	22.0	11.0	3.5
PRT-4G-SWL-SS	1/4	27.8	31.2	19.0	4.7
PRT-6G-SWL-SS	3/8	31.7	36.2	27.0	7.9
PRT-8G-SWL-SS	1/2	37.0	41.0	27.0	11.1
PRT-10G-SWL-SS	5/8	39.0	41.6	27.0	14.3
PRT-12G-SWL-SS	3/4	41.6	45.3	33.0	16.7
PRT-16G-SWL-SS	1	49.7	53.9	41.0	22.2
PRT-20G-SWL-SS	1 1/4	54.4	60.0	48.0	28.6

Swivel Union Tee

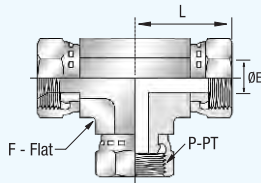

Part No	Pipe Size	Dimensions		
	P-PT, BSPP	L	F	E
PUT-4G-SWL-SS	1/4	30.5	14.0	4.7
PUT-6G-SWL-SS	3/8	33.0	19.0	7.9
PUT-8G-SWL-SS	1/2	38.8	22.0	11.0
PUT-10G-SWL-SS	5/8	39.4	22.0	14.3
PUT-12G-SWL-SS	3/4	42.3	27.0	16.7
PUT-16G-SWL-SS	1	49.0	33.0	22.2
PUT-20G-SWL-SS	1 1/4	58.2	41.0	28.6

Female Cross - NPT

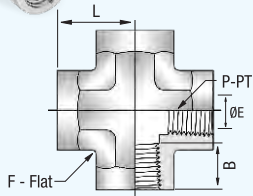

Part No	Pipe Size	Dimensions			
	P-PT, NPT	L	F	B	E
PC-1N-SS	1/16	21.8	11.1	9.9	4.8
PC-2N-SS	1/8	26.4	12.7	10.4	8.6
PC-4N-SS	1/4	29.7	17.5	15.0	11.4
PC-6N-SS	3/8	36.1	20.6	15.0	15.0
PC-8N-SS	1/2	39.6	25.4	19.8	18.5
PC-12N-SS	3/4	48.8	31.8	20.6	23.9
PC-16N-SS	1	48.5	42.9	25.4	29.7

Female Cross - ISO Tapered

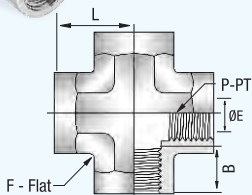

Part No	Pipe Size	Dimensions			
	P-PT, BSPT	L	F	B	E
PC-1R-SS	1/16	21.8	11.1	9.9	4.8
PC-2R-SS	1/8	26.4	12.7	10.4	8.6
PC-4R-SS	1/4	29.7	17.5	15.0	11.4
PC-6R-SS	3/8	36.1	20.6	15.0	15.0
PC-8R-SS	1/2	39.6	25.4	19.8	18.5
PC-12R-SS	3/4	48.8	31.8	20.6	23.9
PC-16R-SS	1	48.5	42.9	25.4	29.7

Other Products

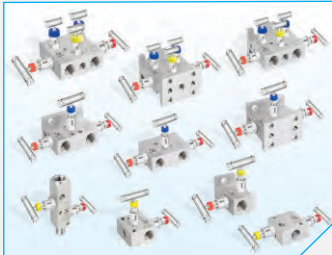

2, 3 & 5 Valve Manifolds

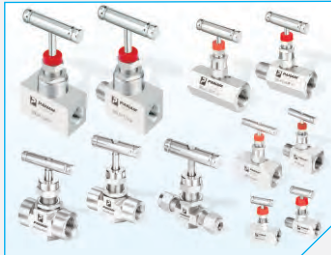

Needle Valves



Ball Valves



Check Valves



Relief Valves



Tube Fittings



Pipe Fittings



Thermowells



Gauge Root Valves

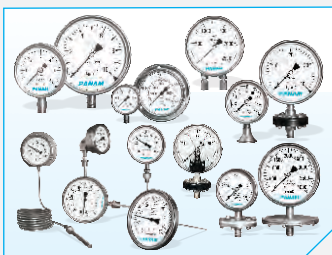

Pressure, Temperature & Diaphragm Gauges



Pressure Transmitters



Pressure Regulators



Double Block & Bleed Valves



Air Header



Industrial Valves



PANAM ENGINEERS LTD.

An ISO 9001:2008 Company

203, Jaisingh Business Center, Parsiwada, Sahar Road, Andheri (East), Mumbai - 400 099. INDIA
Tel.: +91 22 2831 5555 / 57 / 58 • Fax: +91 22 2831 5574 • email: sales@panamengineers.com / sales@panam.in
website: www.panamengineers.com / www.panam.in